

10|2018

# MTA0111

SpaceLine | Mobiler Ausleger - zweiseitig

Im Lieferumfang enthalten

# Montageset RKAA-SZ

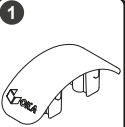
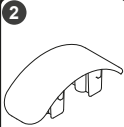
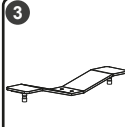
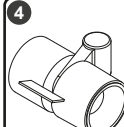
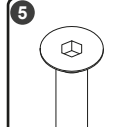
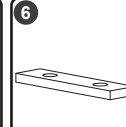

www.oka.de

|   |   |   |   |   |   |  |  |  |  |  |  |  |  |  |
|---|---|---|---|---|---|--|--|--|--|--|--|--|--|--|
| <br>2x<br>SWZ0176K | <br>2x<br>SWZ0175K | <br>2x<br>BLE1126S | <br>4x<br>110948 | <br>4x<br>100097 | <br>2x<br>BLE0131K |  |  |  |  |  |  |  |  |  |
|---|---|---|---|---|---|--|--|--|--|--|--|--|--|--|

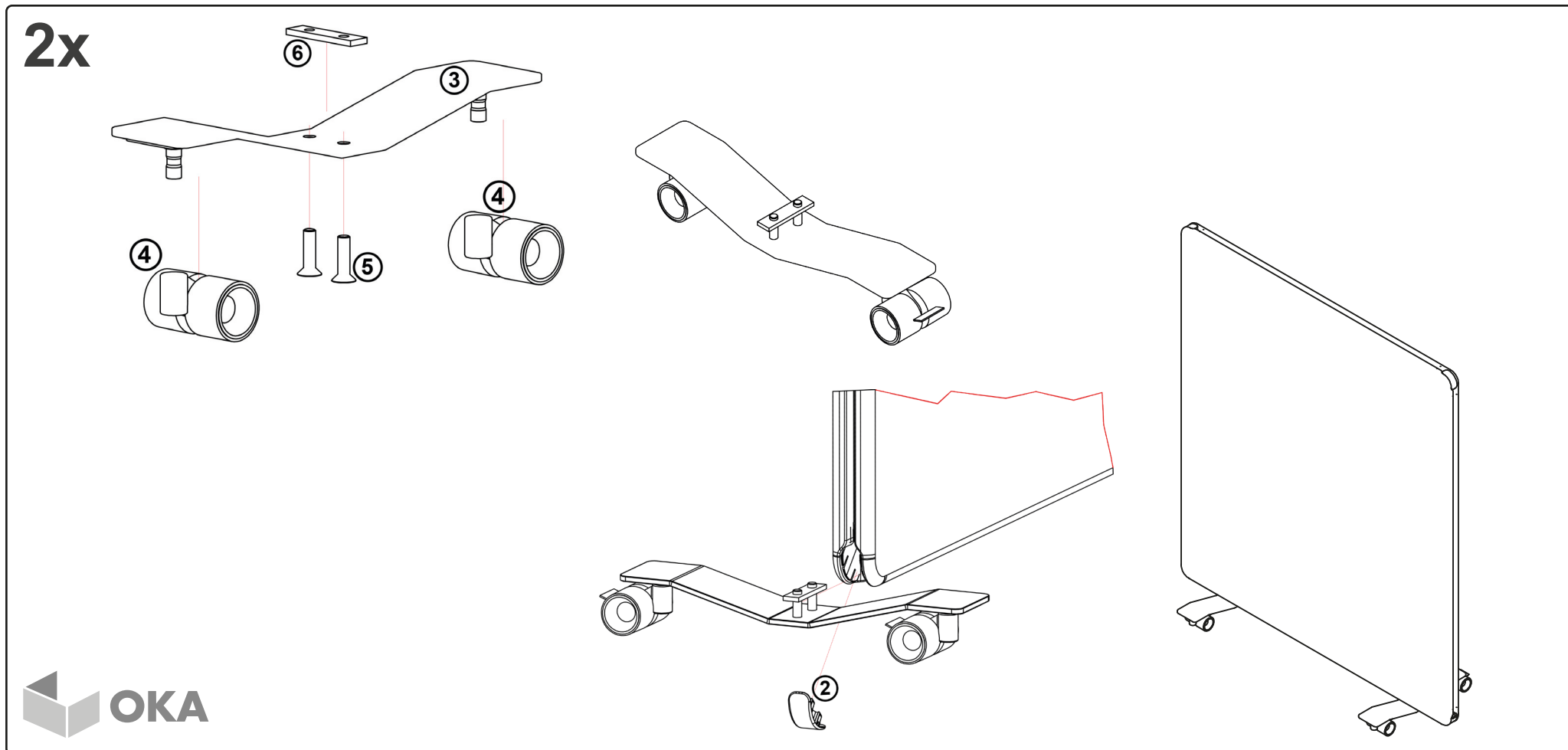

10|2018

# MTA0122

SpaceLine | Mobiler Ausleger

Im Lieferumfang enthalten

# Montageset ZWZU21



|   |                |                |              |              |                |   |   |   |    |    |    |    |    |    |
|---|----------------|----------------|--------------|--------------|----------------|---|---|---|----|----|----|----|----|----|
| 1 | 2x<br>SWZ0175K | 2x<br>BLE1126S | 4x<br>110948 | 4x<br>100097 | 2x<br>BLE0131K | 7 | 8 | 9 | 10 | 11 | 12 | 13 | 14 | 15 |
|---|----------------|----------------|--------------|--------------|----------------|---|---|---|----|----|----|----|----|----|

