

OKA JumpFlex

JumpFlex. Ergonomisch flexibel.
JumpFlex. Ergonomic flexible.





Der Tradition verpflichtet - Made in Germany

// OKA JumpFlex - Der ergonomische Weg zum flexiblen Arbeiten. JumpFlex unterstützt die flexible Arbeitsplatzgestaltung von Heute und ist speziell für den Einsatz in Seminarräumen, Coworking Spaces oder Mehrzweckräumen konzipiert. Eine Kombination aus elektromotorischer Höhenverstellung und mobilem Klappstisch ermöglicht eine hohe Flexibilität bei Berücksichtigung ergonomischer Belange. Sobald Platzbedarf besteht, ist die Tischplatte mit einem Handgriff zurückgeklappt und kann platzsparend zusammen mit weiteren JumpFlex Tischen verstaut werden. Durch die zusätzliche Möglichkeit der Untertischelektrifizierung und Kabelorganisation erfüllt JumpFlex alle Anforderungen für die Ausstattung eines vollwertigen Arbeitsplatzes.

// OKA JumpFlex - The ergonomic way to work flexibly. JumpFlex supports today's flexible workplace design and is specifically designed for use in seminar rooms, coworking spaces or multi-purpose spaces. A combination of electromotive height adjustment and mobile folding table allows a high degree of flexibility with consideration of ergonomic concerns. As soon as space is required, the tabletop is folded back with one movement and can be stowed away with other JumpFlex tables to save space. Due to the additional possibility of under-table electrification and cable organization, JumpFlex meets all the requirements for equipping a full-fledged workstation.



// Schnellklappfunktion
// fast folding function



// Abklappsicherung
// folding safety catch



// 360° Lenkrollen bremsbar
// 360° castors with brake



// Beinraumbende
// modesty panel

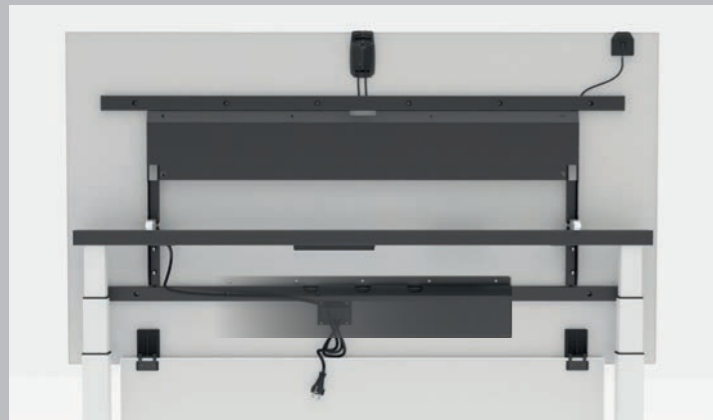

// Kabelmanagement ohne/mit horizontalem Kabelkanal
// cable management without/with horizontal cable duct



// Steckleistenmodul mit optionalen Kabelkanal
// headers module with optional cable duct



// Doppelhub elt. HV 69-122cm
// 2 Bedienpanel: Auf/Ab oder LED mit Memory
// Anti-Kollisionsschutz
// electric motor driven double-lift height adjust. from 69-122 cm
// 2 control panel: Up/Down or LED with memory
// Anti-Collision-Control



// OKA ist zertifiziert nach:
// OKA has been certified according to:



// OKA Produkte sind zertifiziert nach:
// OKA products have been certified according to:



Melamin Uni-Dekor
melamine

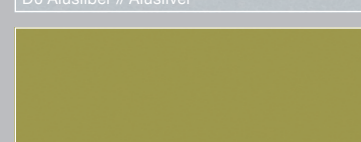
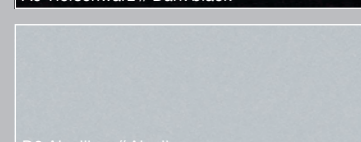
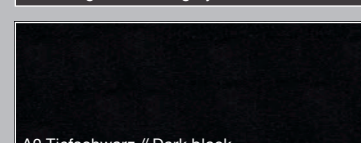
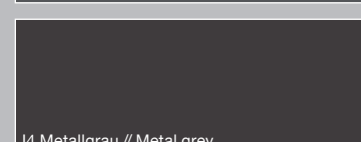
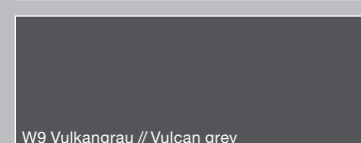
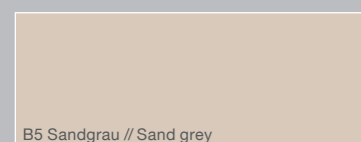
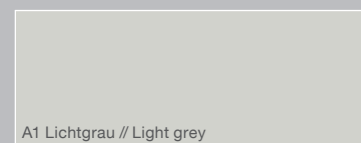
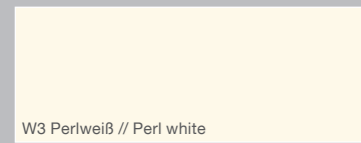

Melamin Holz-Dekor
melamine wood laminate

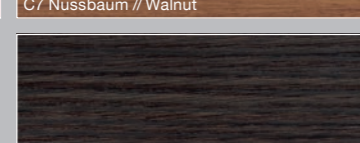
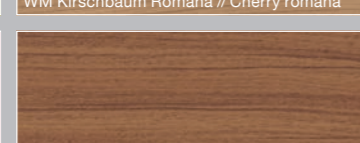
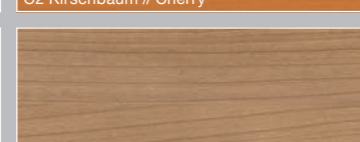
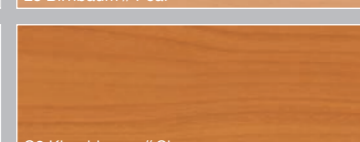
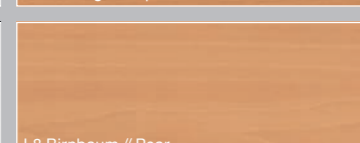
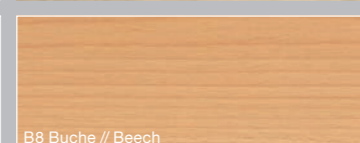
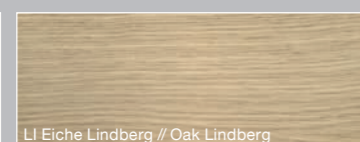
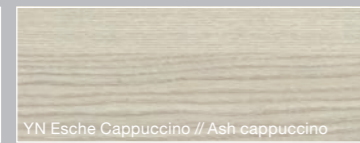

Echtholz Furnier
real wood veneer

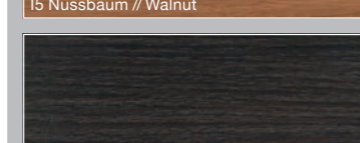
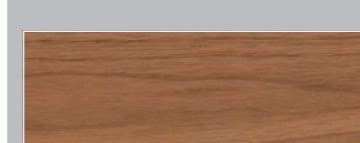
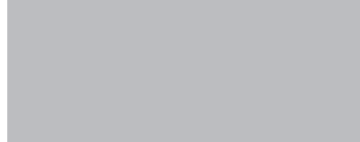
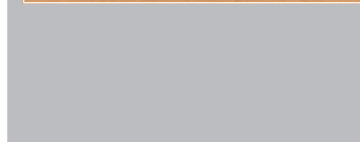
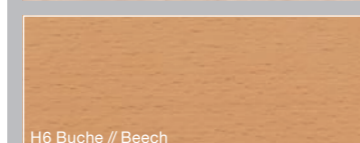
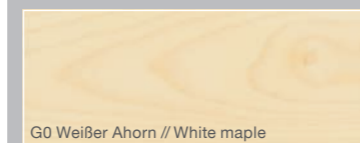
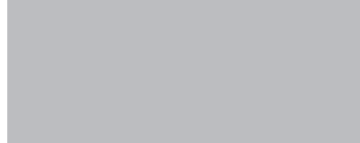

Metall ^{glatt}
metal ^{smooth}

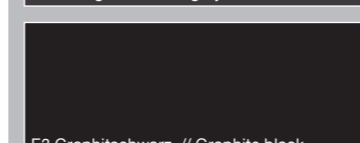
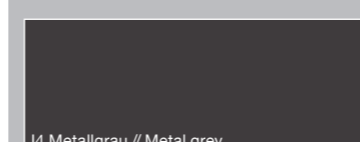
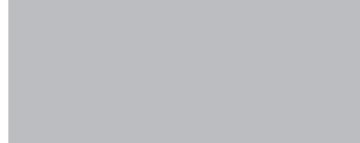
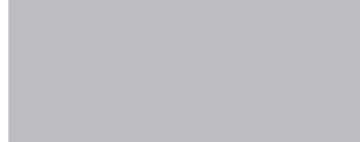
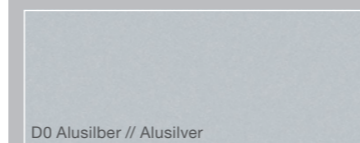
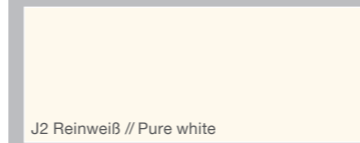

Schreibtische // Desks

Rechteck Typ 1

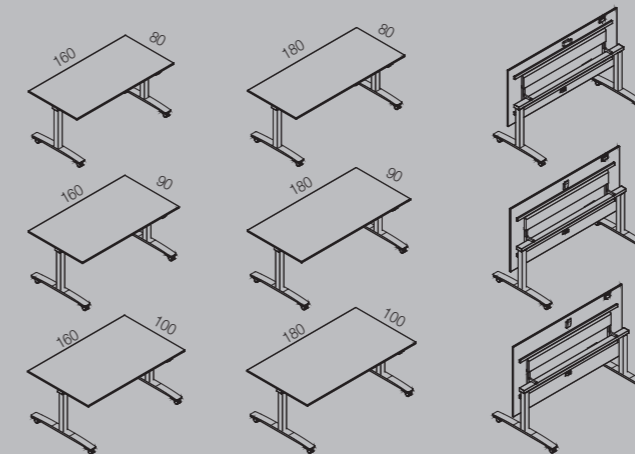



wir sind ihr büro.

OKA Büromöbel GmbH & Co. KG

Eibauer Straße 1–5 // D-02727 Ebersbach-Neugersdorf // Germany

tel 0049.3586.711-0 // fax 0049.3586.711-170

www.oka.de

Alle Rechte bei OKA Büromöbel GmbH

All rights: OKA Büromöbel GmbH

Gedruckt in Deutschland auf chlorfrei gebleichtem Papier.

Printed in Germany on chlorine-free bleached paper.